

FOLDABLE DRONE

MANUAL



IMPORTANT STATEMENTS AND SAFETY GUIDELINES

Thank you for choosing this product, in order to make it easier for you to use this drone, please read this manual carefully before operating it, and please save this manual for adjustment and repair the drone in the future.

Important Statement

- This product is not a toy, it integrates expertise in mechanics, electronics, aerodynamics, high-frequency launching, etc.
This drone integrates precise equipment, which requires proper assembly and commissioning to avoid accidents. The drone holder must operate the drone in a safe way; improper handling will cause serious personal injury or property damage.
- This product is suitable for people who have experience in operating drone and older than 14 years old.
- In case of the problem of use, operation, maintenance, etc., please contact your local dealer or the relevant staff of the company. Factory and the seller is not responsible for any injury or damage caused by improper use or operation.
- The product contains tiny parts, so keep them out of the reach of children to avoid eating or suffocating.

Safety Precautions

The RC drone is a dangerous commodity, please stay away from the crowd while flying. Improper assembly or damage the drone, poor control, and unfamiliar operation cause unpredictable accidents such as drone damage or personal injury. Pilots should pay attention to flight safety, and understand the responsibility of the accident caused by negligence.

- Stay away from obstacles and people

The flying drone has an uncertain flight speed and state, there is a potential danger. Flying away from crowds, high-rise buildings, high-voltage power lines, etc., while avoiding flying in windy, rainy and lightning. Commissioning and installing the drone must be strictly in accordance with the instruction, be careful the distance between the drone with the people should maintain in 1-2 meters. Avoiding the drone hit the head, face, and body in flying and landing.

- Keep away from the humid environment.

The interior of the drone is composed of many sophisticated electronic components and mechanical parts. Therefore, it is necessary to prevent the drone from getting wet or moisture, so as to avoid accidents caused by mechanical and electronic component failure. Use a clean rag to clean the surface stains during the maintenance.

- Guided by the experienced pilot

The control skills have certain difficulties in the early stage of learning. Try to avoid flying alone, and you need to be guided by experienced pilot.

- Use this product correctly

Please repair the drone with original parts to ensure the safety of the flight. Please operate the product within the scope permitted by the product features and can be used for illegal purposes.

- Safe operation

1. Please operate the drone only you are in good shape and have flying skills. Fatigue, trance or improper operation will increase unexpected risks.

2. Don't use it near your ears! Misuse can cause hearing damage.

- Keep away from high speed rotating parts

When the motors of the drone are rotating at high speed, please keep the pilot, the surrounding crowd and objects away from the motors to avoid injury and damage.

- Keep away from heat

The drone is made of metal, fiber, plastic, electronic components, and other materials, so you should keep it away from heat sources and avoid the sun and high temperature, so as to avoid causing the deformation of the drone.

- Environmental requirements

Discarding this product at will may pollute the environment. Please dispose it properly according to the local laws and regulations.

Product Description

Product Configuration

Package included

E511s drone*1 blades set *2 Guards*4 USB charging cable*1
Screwdriver*1 Remote control*1 Battery*1

Basic parameters

Wheelbase: 170mm Height: 75mm Total weight: about 310g

Battery: 7.4V 1200mAh 25C Charging time: about 3 hours

Flight time: about 15-16 minutes

Product Assembly

Blades (with blades clip clamp) installation / demolition

Blades installation:

Install the blades with A on the fixed position of the arm A, install the blades with B on the fixed position of the arm B, use a screwdriver to unscrew the middle screw and remove the entire blades clamp which with two blades, then replace a new one (included in the package), then presses it down, locks the screw and locks it in place.

Tip:

You don't need to replace single blades, just replace the whole blades clip clamp which with two blades (included in the package).

If you replace single blades, remove the screw on the blade by turning the screw counterclockwise. Be careful don't lose the screws.

⚠ Tips: Please folding the drone in the order shown in the figure below. Please install the blades as referring to the picture as shown, The blades are divided into A and B part, be careful of the direction of rotation.

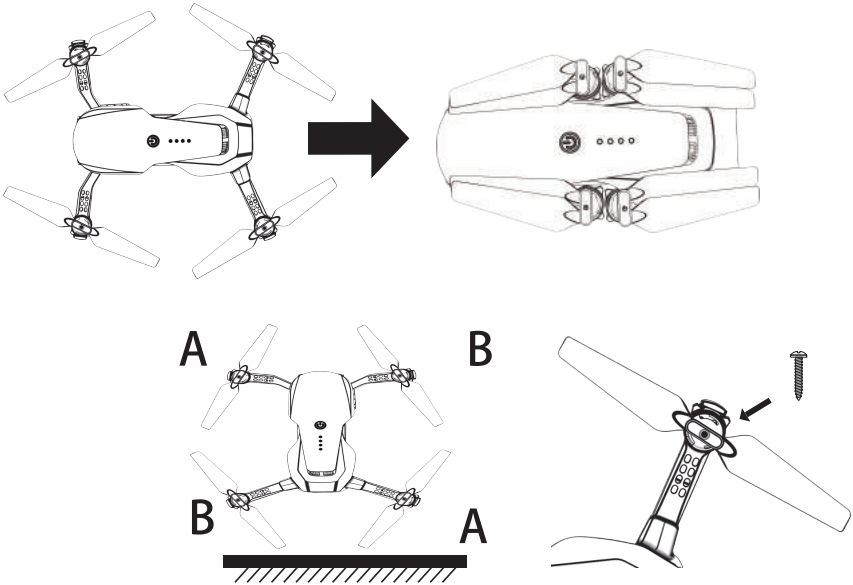

- ⚠**
- Make sure that type A and B blades are installed in the correct position. If install the blades improperly, it can't take off.
 - Since the blades are thin, be careful to prevent accidental scratches when installing.
 - Please use the original blades provided by our factory.
 - The blades are the consumable item. If necessary, please purchase it separately.

Shelter installation

Insert the two posts on the guards into the 2 holes on the bottom of the motors, and then use a screwdriver to lock the screws to hold guards.

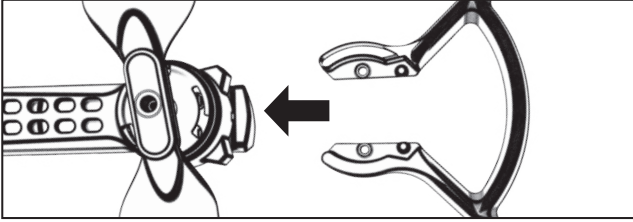

Charge the battery of the drone

Pressing and pull the battery out of the main body of the drone, insert the USB into the adapter (Not included), the USB indicator lights up red, insert the battery into the USB output, the USB indicator flashes green, and charging begins. When the charging is completed, the red and green lights are on, and the charging time is about 180 minutes.

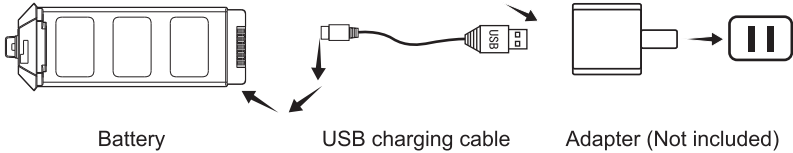

⚠ Tips:



- Do not charge the battery on the carpet to avoid fire. We will not take any responsibility for injury and damage, caused by the improper charging.
- Insert the plug in the correct way. Do not reverse insert.
- It is recommended to use the 5V 1-2A adapter for charging.
- It is not encouraged to use the computer USB port for charging.

Install Battery of Drone

Push the battery into the battery slot of the drone, and the battery is fully clamped in the drone. Check to make sure the battery is in place.

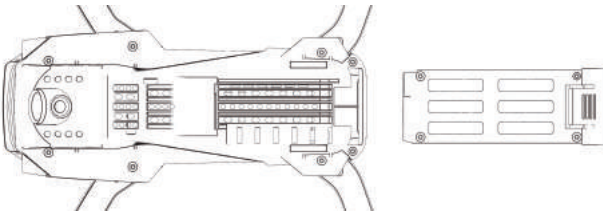

⚠ **Reminder:** If the battery is not installed properly, It is very likely that the drone power off aerially and causes the falling object.



- When charging the rechargeable battery, keep away from children and must be under adult supervision.

Keep away from flammable materials. Charging the battery under the surveillance area. When there is no one in the room, do not charge it.

- Please prevent short circuit or squeeze the battery.
- The battery connector should not be removed from the drone and avoid short circuit. Avoid short circuit and decompose of battery, or put it into the fire; Do not put the battery near the heat resource (such as in a fire or near the electric heat device).
- The battery can only charge by the recommended charger, the battery and charger can't get wet, The drone can be wiped by clean rag, pulling out the battery and disconnect from the charger before cleaning. Periodically check the chargers wires, plugs, fuselage and other, If it is found to be damaged, stop using it until it is repaired.
- The charger is not a toy; the charger can only be used indoors.
- The battery after the flight needs to be recharged before stored. If you don't use the battery in a long term, it is recommended to charge the battery once at least in every 3 months to prevent the battery from being over-discharged and permanently damaging.

Drone Part Name

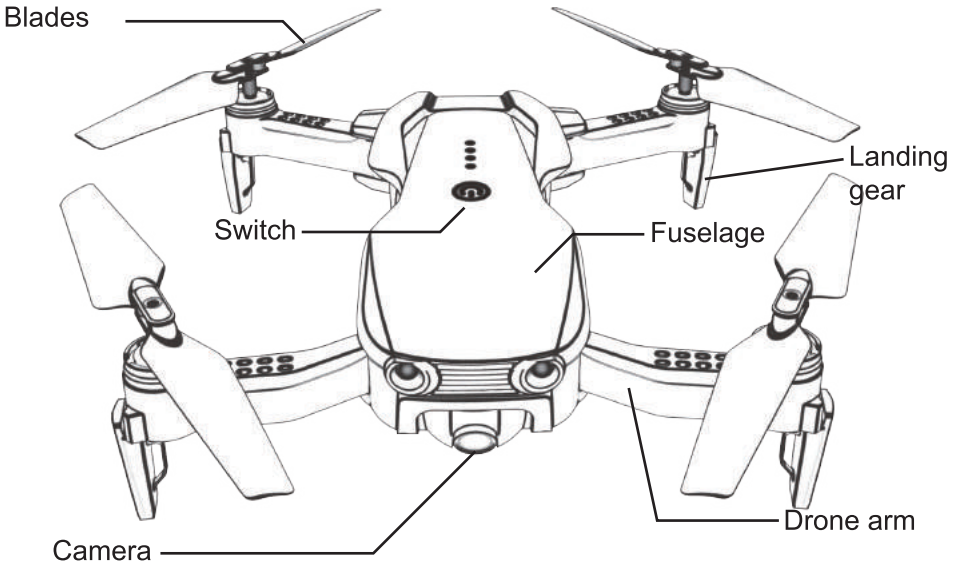

Remote Control Part Name

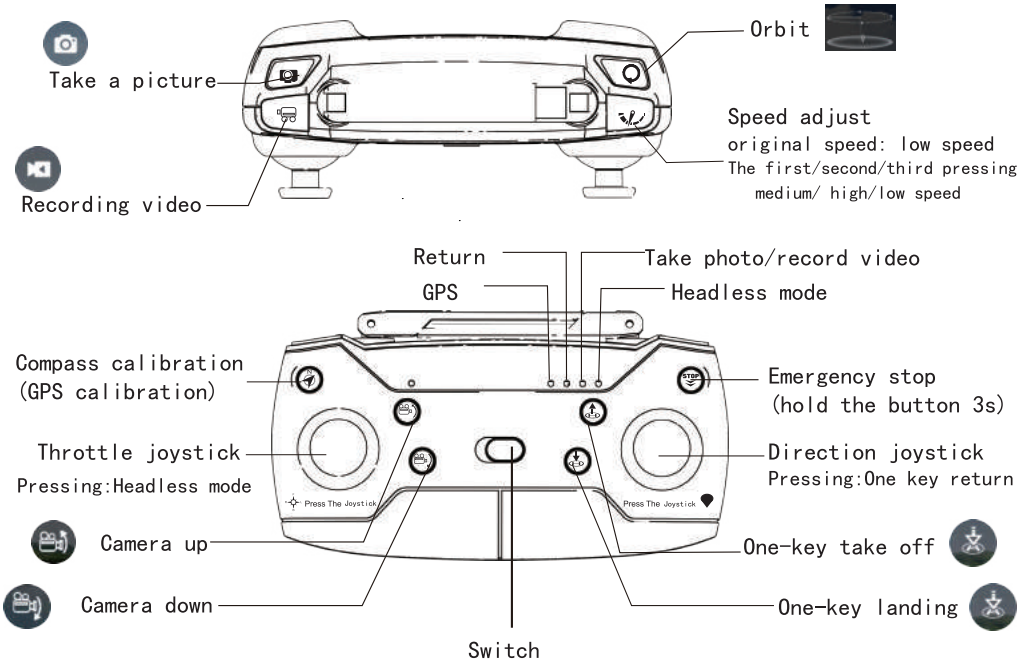

Install the remote control battery

Remove the remote control battery cover, follow the anode and cathode polarity indicated by the remote control, correctly insert the 4 AAA batteries, and then re-install the battery cover.

Remote control battery installation:

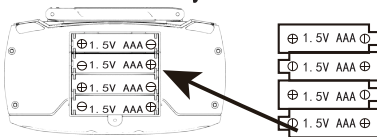

4 AAA Batteries (Not Included)



- The remote control uses 4 “AAA” non-rechargeable batteries or “AAA” rechargeable batteries. (Not included)
- Pay attention to the polarity of the battery when installing or replacing the battery.
- Do not mix different condition or types of batteries.
- The used battery should be taken out in time, and the discarded battery should be thrown properly.
- If you do not use it for a long time, please remove the battery to avoid damage the product caused by battery leakage.

Synchronize the drone with the remote control.

1. Insert the battery into the battery compartment of the drone. Put the drone on the horizontal plane. Press the power button of the drone for two seconds to turn it on. The indicator light of the drone flashes quickly and then flashes slowly.
2. Turn on the remote control power switch. The synchronization is completed, the indicator light of remote control turns on solid, and the front indicator light of the drone is bright.

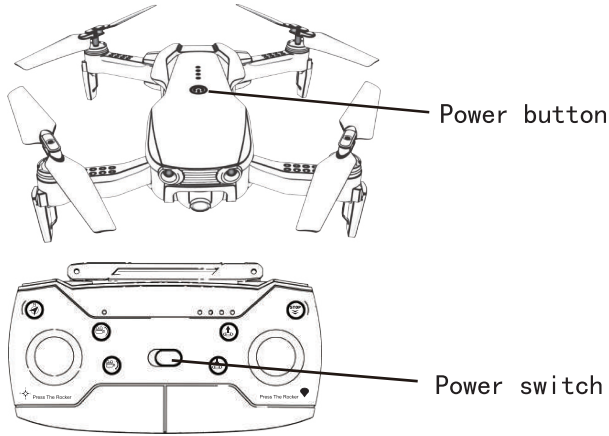

- Without any drone synchronizing with other remote controllers, your remote control and your drone don't need to synchronize again, as long as the syn is successful.
- When the remote control is synchronizing with the drone, please make sure that there do not have others remote control and the drone is powered on at the same time. Otherwise, it can be failed or wrong.

Drone Initialization Detection

After the synchronizing procedure is finished, keep the drone on the horizontal plane, it will automatically begin the initialization detection. The drone needs about 8 seconds to complete the initialization detection on the stationary plane. Next step, the drone need to begin the gyro calibration procedure.

Gyro Calibration

After synchronization and initialization are successful, put the drone on the horizontal plane, push the left and right joysticks to the lower right 45° at the same time as the figure below. Then the front and rear indicators light of the drone flash rapidly, the gyroscope is calibrating, finally the indicator light changes from flashing to steady light, the gyroscope calibration is completed.

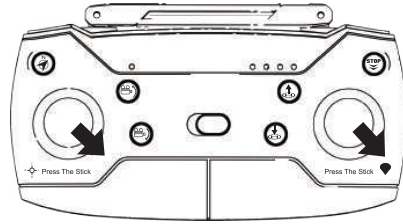
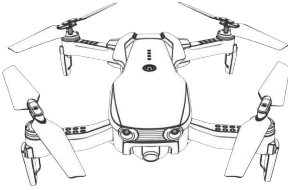

- !**
- When performing the procedure, be sure to put the drone on a horizontal plane, otherwise, the drone can't fly in balance.
 - The gyroscope is calibrated at the factory, and the user is not required to calibrate it. This operation is only performed when the initialization can't be exited.

Compass Calibration

1. After the drone synchronizes with the remote control successfully, completed the initialization test and gyro calibration, then perform the compass calibration.
2. Every time before the drone take off, it must be performed compass calibration, otherwise, the drone will not be able to fly normally.

Compass calibration is divided into two steps:

Firstly press the compass calibration button as figure below.

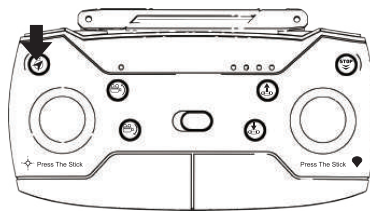

Step 1: Horizontal calibration of the compass(Figure 1)

Then use your hand spin the drone as shown below and rotates it counterclockwise horizontally for about 3 times until the indicator light is on, The horizontal calibration is completed.

Step 2: Vertical calibration(Figure 2)

Erecting the drone and rotate the drone with your hand , as the figure 2 below, rotate the fuselage clockwise about 3 times until the indicator light on the front of the aircraft is always on. The compass calibration is complete.

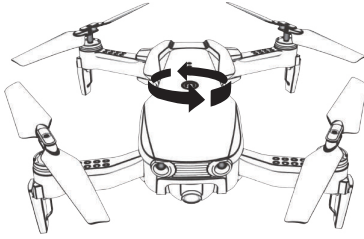

Figure 1

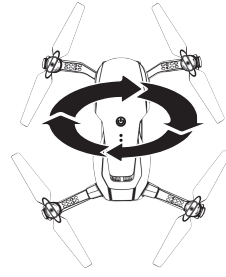

Figure 2



- Note: The best distance between the ground and the drone should be more than 1 meter during calibration.
- Do not calibrate the drone in strong magnetic fields, such as magnetite mine, parking lots, and foundation building of steel and concrete.
- When performing the calibration, do not carry ferromagnetic substances such as keys, mobile phones etc.
- Do not performing the calibration near large pieces of metal.

Search satellite signals

After the compass calibration procedure is completed, put the drone on the horizontal plane, the drone will automatically search for the satellite signal, the indicator light of the drone will change from slow flashing to steady light, and the remote control emit a beep ,then the procedure of search satellite signal is completed. Unlock the drone by pushing the left joystick to left 45° and the right joystick to the right 45° at the same time(as the picture shown), the motors will spin, then push the throttle stick, the drone will take off.

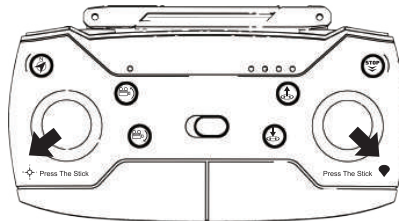

Tips: Please make sure that the drone fly in wide open space and the satellite signal is more than 7 stars show in the app before take-off.

FPV real-time transmission application download and Connection



Google play



IOS



Andrew system is required to open the APP and update the map of your location before connecting drone wifi

START

Click the START button to enter the control interface

This screenshot shows the main control interface of the FPV application. The top status bar displays flight data: Altitude: 0.0m, Distance: 0.0m, speed: 0.0m/s, HD signal strength, and battery level. Below this, a central map area shows a 3D landscape with a bridge. On the left, a vertical toolbar contains icons for flight mode switching, joystick, return, take-off/landing, VR 3D mode, and album. On the right, another vertical toolbar contains icons for taking a photo, recording video, camera up/down, and map preview. A 'Setting' gear icon is in the top right. Callout boxes provide details for several elements: Flight speed (Vertical and Horizontal), parameter (Latitude, Longitude, Number of satellites), Euler Angle (Roll, Pitch, Yaw), Wifi signal range, Setting, Altitude / Distance, Battery power of drone, Map preview switch, Take a photo, Recording Video, Camera up, and Camera down.

Ps: when you use the joystick of remote control, you need to close the virtual joystick of the app, they can't work at the same time.

This screenshot shows the virtual joystick menu overlaid on the main interface. The menu is titled 'hover / Lock' and contains four options: 'Self...izing', 'Waypoint', 'Follow', and 'Orbit'. Below these options are four corresponding buttons: 'hover/stable', 'Waypoint', 'Follow me', and 'Orbit'. A red box highlights the menu area, and a callout box labeled 'Flight mode switching' points to the top-left icon of the menu.

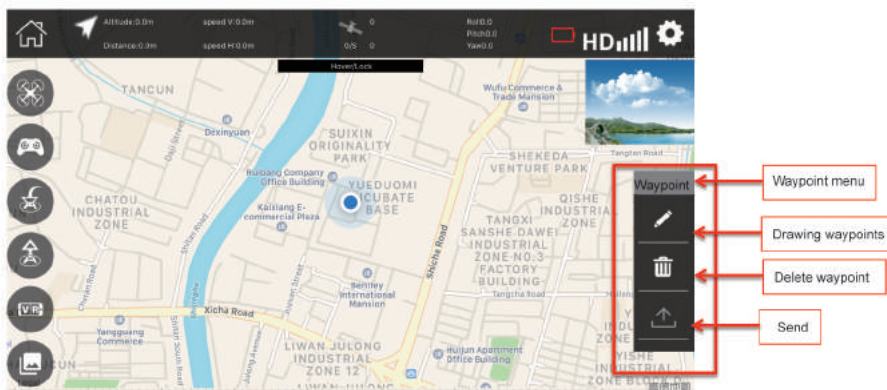

Set the waypoints by a continuous line drawing

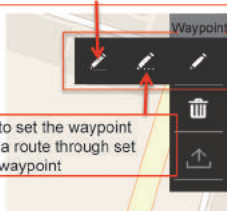

Delete a single waypoint, click the button, and then click the waypoint you want to delete.

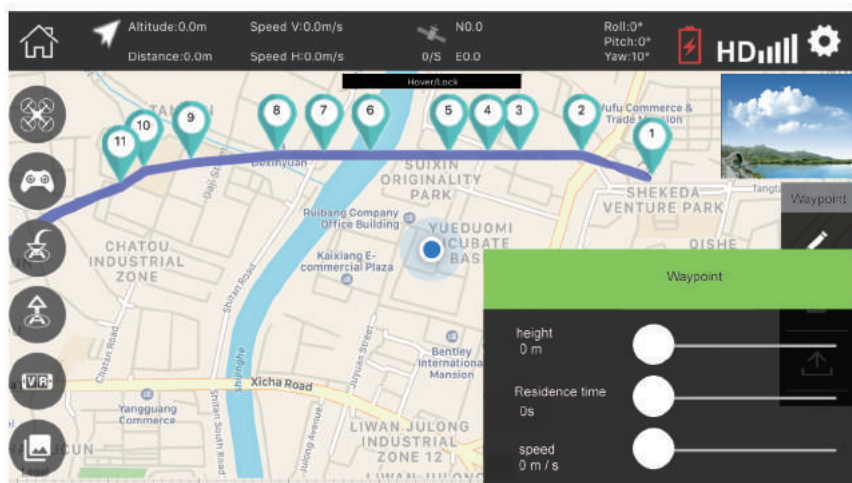
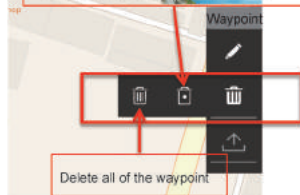

Waypoint parameter setting

Click the waypoint you want to set, then the App will pop up the setup menu. Press and slide the icon to modify the parameters



*Press Self-stabilizing mode to exit the Waypoint mode

1. Make sure the phone GPS function works.
2. Press Self-stabilizing mode to exit the follow me mode

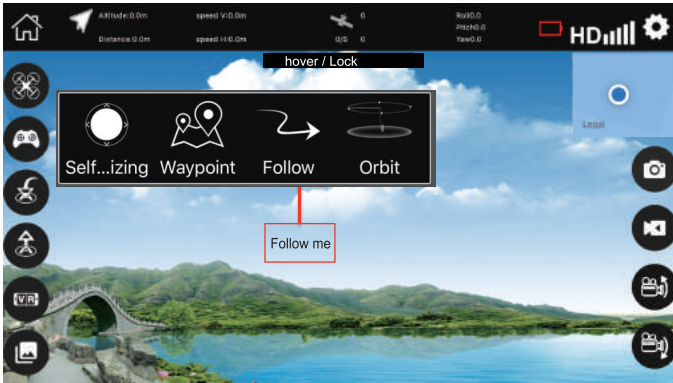

In follow me mode, the mobile phone continuously sending the location to the drone, the drone will follow your phone.

When the virtual joystick and the actual joystick activates simultaneously, the actual joystick would take primary control for the direction of orbit mode.



Press the orbit mode icon that the drone will fly surround the mobile device, at the same time push the direction (right) joystick up or down to control the radius decrease or Increase, push the direction joystick to left or right, that will control the surround direction turning clockwise or counterclockwise. Pushing the throttle (left) joystick to control the drone ascend or descend.

Flight

Basic Flight





Step

1. Synchronize the remote control and the drone, then the drone will automatically finish initialization.
2. Perform the synchronize gyro calibration procedure.
3. Download the APP and the drone with the mobile phone with Wifi.
4. Performing the Compass Calibration procedure. Wait for the drone automatically search satellite signals, usually 60-80 seconds (signals should be more than 7 stars), until the rear light of the drone is steady on, signals receiving finish.
5. Unlock the drone, then push the throttle stick up, the drone takes off.

Pre-Flight Inspection

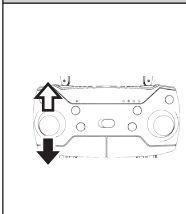
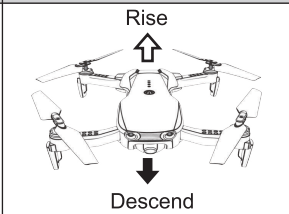
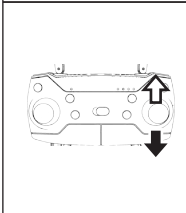
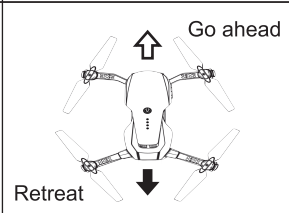

1. Ensure the battery of remote control and drone is fully charged.
2. Ensure the blades installed correctly.
3. Ensure the compass calibration successful.
4. Ensure the drone received satellite signal more than 7 stars.
5. Check the motors work fine after unlocking the drone.

Flight Control

Remote control	drone	Remote control	drone
	<p>Rise</p>  <p>Descend</p>		<p>Turn right</p>  <p>Turn left</p>
	<p>Go ahead</p>  <p>Retreat</p>		<p>Fly to the left</p>  <p>Fly to the right</p>

Function

One-Key Take off / Landing

- Unlocked the drone, press the "  "button and the drone will automatically take off and rise about 1.5 meters to hover.
- When the drone flying, press the, "  " button and the drone will automatically landing.

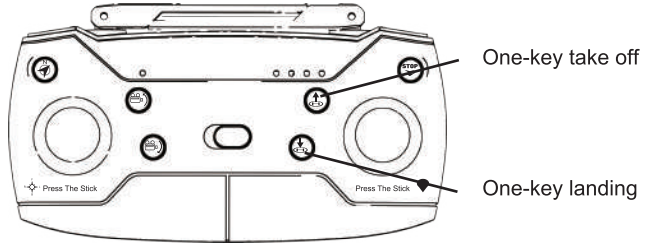

Orbit Mode

Ascending the drone 20 meters or higher from the ground. Press the orbit button and the head of the drone turns back to the previous direction and hover, push the remote control direction (right) joystick to the left or right, the drone will fly Clockwise or Counterclockwise, In the orbit mode, press and hold the direction (right) joystick, the drone accelerates to 2.5M/S. Pulling down the direction (right) joystick to expand the radius. The maximum radius is approximately 20 meters. Pushing up direction (right) joystick to reduce the surrounding radius, the minimum is about 5 meters. Pressing the orbit mode button again to exit the orbit mode.

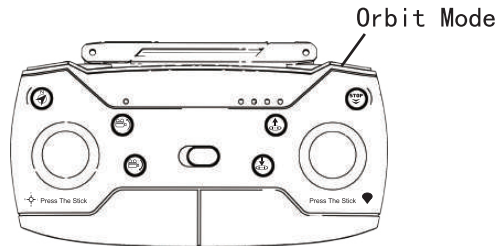

Headless Mode

Before using the headless mode, the drone should rise 5 meters from the ground. Pressing the throttle joystick to activate the headless mode, then the rear indicator light of the drone will flash quickly and the remote control beep once, headless mode on. Pressing the throttle joystick again to exit.

Headless mode
Pressing the throttle joystick

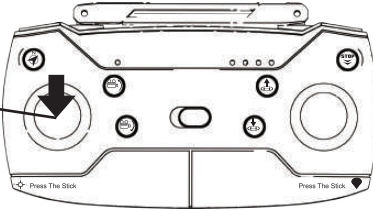

Return

Starting point:

During the take-off or flight, when the GPS signal strength more than 7 stars for the first time, the current location of the drone will be recorded as the starting point.

The drone have return function. If starting point successfully records before take off. When the signal between the remote control and the drone is loss, the return button is pressed or drone is in low power.

The drone will automatically return to the starting point and landing to prevent accidents.

The drone has three different return modes:

1. One-key return (the drone will automatically return to the starting point by pressed the direction joystick)
2. Out of control return(the drone will automatically return to the starting point, when it is beyond the remote control range or loses connection)
3. Low power return.(the drone will automatically return to the starting point,when drone is in low power)

One-key return mode

When the GPS signal strength more than 7 stars, the drone can return by pressing the direction joystick of the remote control. The one-key return mode is the same as the out of control return mode, but the user can control the drone to avoid obstacles by the joystick, when the drone returns near the landing, pressing the one key return button, you can exit the automatically flight and regain control.

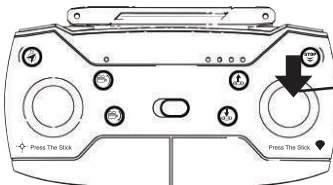

One-key return mode
Pressing the direction joystick

Out Of Control Return

If the GPS signal strength more than 7 stars, the compass works fine, the drone successfully records the starting point and the remote control signal is lost for more than 6 seconds, the flight control system will take over control of the drone and control the drone fly back to the starting point. Even the signal of the remote control is restored during the flight, the drone will continue to return, but the user can exit the flight control system and regain control of the drone by pressing the direction joystick of the remote control.

-
-  **Notice:**
- The drone can't dodge obstacles during the automatic return flight.
 - When the GPS signal is not good or the GPS function is not working, it can't return.
 - If the drone did not receive the satellite signal and the remote control signal lost more than 6 seconds, the drone unable to return to the starting point, and it will slowly descend, landing and lock.
-

Low Power Return

- The rear indicator light of the drone flashes slowly. At this time, the remote control continuously emits "beep beep beep..., beep beep beep...". As long as the drone flies higher than 20 meters or the distance between the drone and the remote control farther than 20 meters, the drone will automatically carry out the return function. Fling back to the starting point.
- The voltage of drone below the safe value, the drone will automatically landing to the starting point

-
-  **Tips:** When the drone is in a low-power state and returning starting point, the remote control can't cancel the return.
-

Take a Photo / Recording Video

During the flight, the camera can adjust the angle up or down, press the camera up the button of the remote control for each time, the camera lens ascends about 10 degrees. When the camera is in the maximum angle and the remote control emits , how many time you press it, the camera can't ascend, the camera down button is the same.

During the flight, you can use the camera/video button of the remote control to capture the aerial image. Pressing the camera button, the camera will take a photo, at the same times the remote control emits "beep", holding the video button, and the camera will start recording video, at the same times the remote control emits "beep" twice , holding this button again to finish.

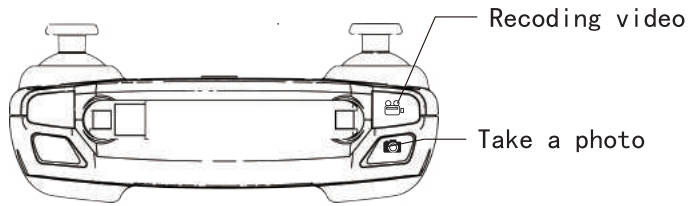

Common troubleshooting

Serial number	Problem	Solution
1	The indicator light continues to flash rapidly after the drone is powered.	The drone is in the gyroscope detection state, please put the drone in a stationary surface or the ground.
2	After the drone takes off, it can't hover and tilt to one side.	Put the drone on a flat or level surface and calibrate the gyroscope.
3	The drone is shaking very badly	Blades deformation, it needs to replace the blades.
4	The drone can't be unlocked, the tail lights flash quickly	The battery voltage of the drone is too low, please fully charge the battery